

4 3 2 1

F

F

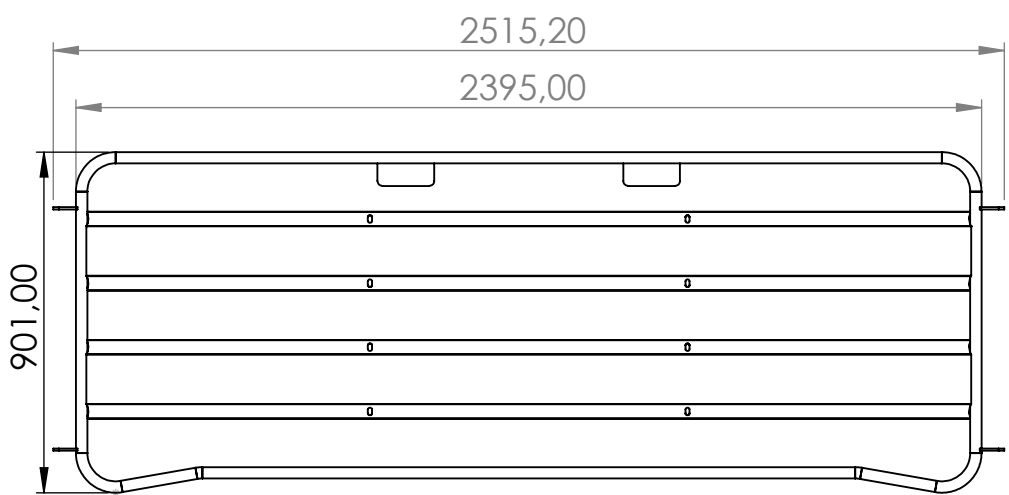

E

E

D

D

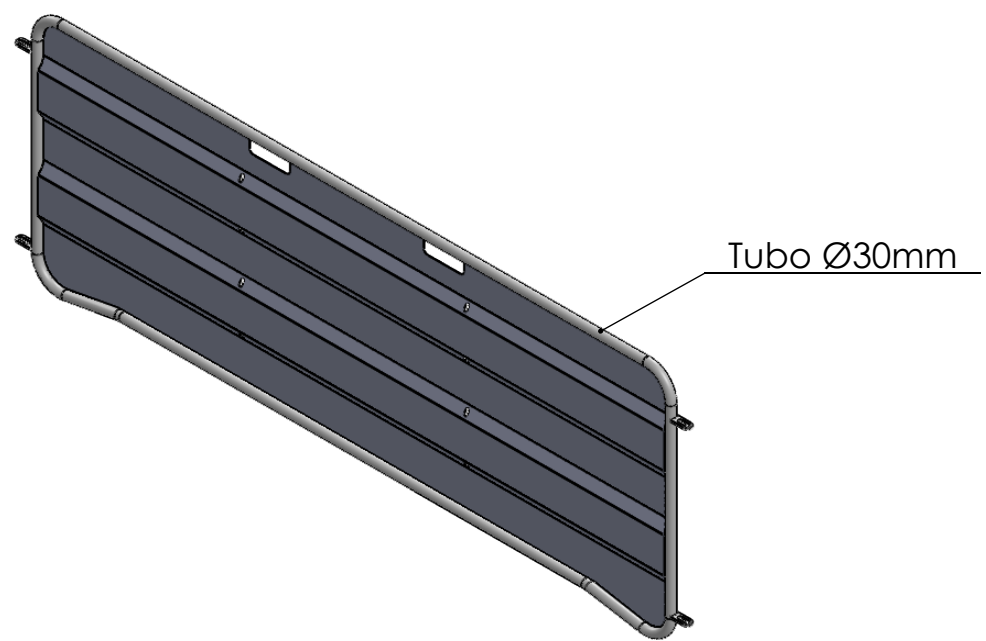

C

C

B

B



JAVIER CAMARA
INDUSTRIAS GANADERAS

	NOMBRE	FECHA
DIBUJADO		12/11/2020
REVISADO		

A

A

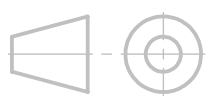

Nº DE PLANO

G211

ESCALA: 1:20	MATERIAL:	ACABADO:	RUGOSIDAD:
-----------------	-----------	----------	------------

A4	HOJA 1 DE 1	PESO:	TOLERANCIA GENERAL 2768mk
----	-------------	-------	---------------------------

4 3 2 1