

Longitud parte fija (mm)	1625
Longitud parte extensible (mm)	1768

	Sin extender	Extendido
Longitud máxima (mm)	1893	3013
Longitud de acople (mm)	1500	380

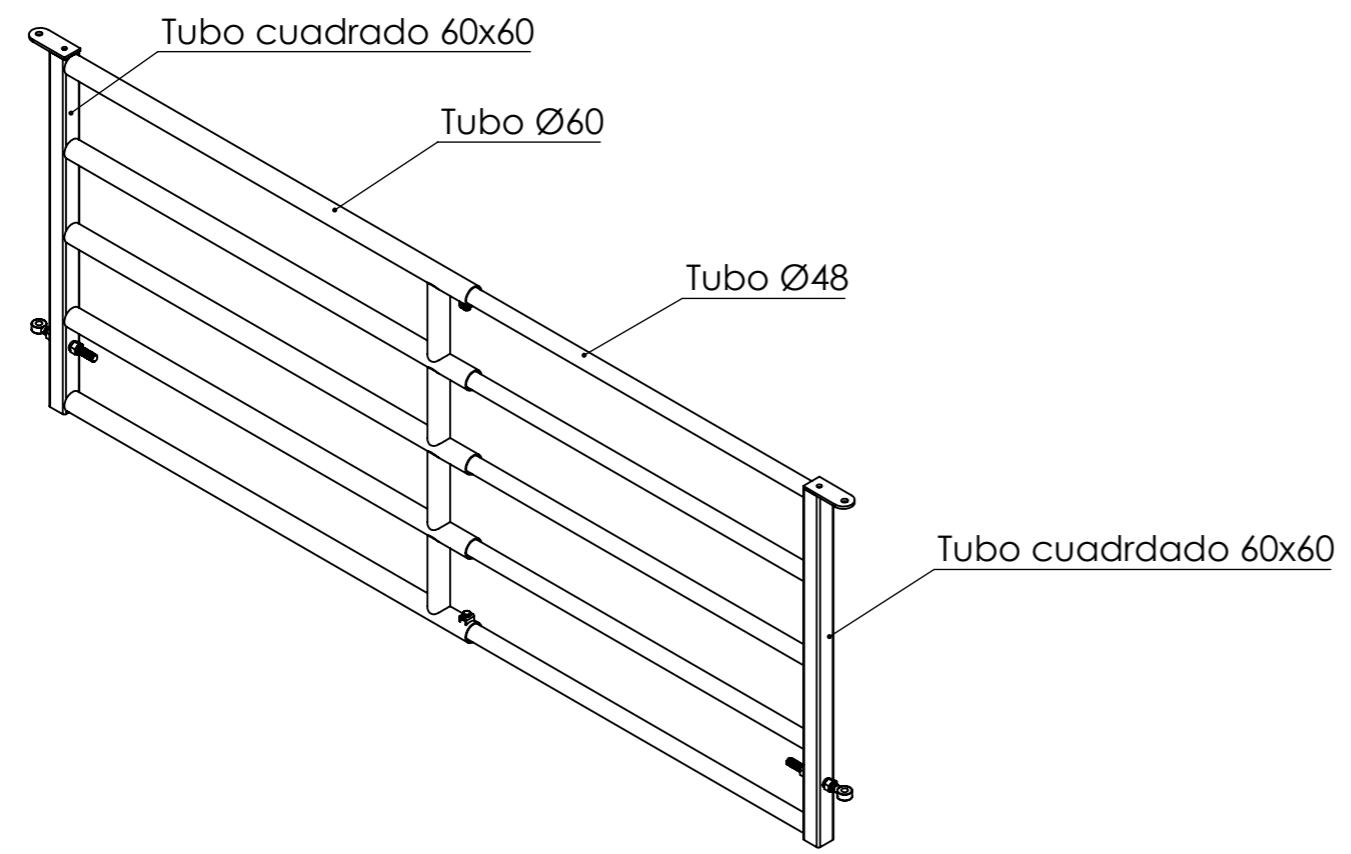

	JAVIER CAMARA INDUSTRIAS GANADERAS		NOMBRE	FECHA	
			PIEZA	JAVIER ARACIL	13/10/2021
ESPELOR: mm	DESCRIPCIÓN:		PLANO	JAVIER ARACIL	28/10/2021
MANO:	DIMENSIONES GENERALES (CH DESPLEGADA): mm		PRODUCTO: Panel extensible de 2 a 3 metros		
ESCALA: 1:20 HOJA 1 DE 1	FABRICADO:	MATERIAL:	CÓDIGO: G421-P		